

Bluelab PeriPod M3

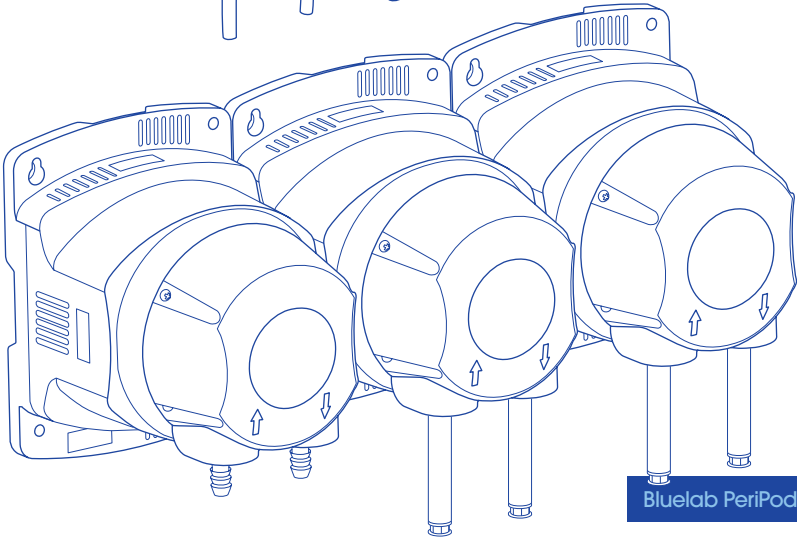

Bluelab PeriPod L3

CE FC



2
YEAR

6 months for pumps and tubes

Contents

	page		page
1.0 Introduction & Overview:		5.0 Multi-part Nutrient Dosing with BlueLab PeriPods	
1.1 Features	3	5.1 Reservoir size	13
1.2 What's in the box?	3	5.2 Starting with multi-part nutrient dosing	14
1.3 How the BlueLab PeriPod works	4	5.2.1 Setting up the PeriPods	14
2.0 Safety Precautions:		5.2.2 Setting up Connect	15
2.1 General safety precautions	5	5.2.3 Calculating the on time with multi-part nutrients	16
2.2 Chemical safety precautions	5	6.0 Maintenance, Troubleshooting & Specifications:	
3.0 Installing the BlueLab PeriPod:		6.1 Maintenance	17
3.1 Mounting the BlueLab PeriPod	6	6.2 Firmware upgrading	17
3.2 Setting up the inlet and outlet tubes	6	6.3 Troubleshooting guide	17
3.3 BlueLab PeriPod connection panel	8	6.4 Technical specifications	19
3.4 Connecting to a BlueLab Pro Controller	8	6.5 Material specification for tubing	19
3.5 Connect power adapter	8	6.6 pH adjuster compatibility for tubing	19
4.0 Set up and Operation:		7.0 Accessories, Parts & Guarantee:	
4.1 Manual pump priming	9	BlueLab accessories & parts	20
4.2 Calibrating nutrient pumps	10	BlueLab limited warranty	22

1.0 Introduction & Overview

1.1 Features

Bluelab PeriPod M3 & M4

3 or 4 120ml/min peristaltic pumps which can be set to dose pH adjuster or nutrient stock solutions.

Bluelab PeriPod L3

3 x 1200ml/min peristaltic pumps which can be set to dose pH adjuster or nutrient stock solutions.

Rugged wall mount design.

Individual pump calibration and pump priming.

4 metres / 13 feet of acid / alkaline resistant food grade tubing for dosing pH correction solution.

3x 4 metres / 13 feet per pump of tubing for dosing nutrient stock solution.

Replaceable peristaltic pumps and tubing.

Compatible with most modern growing systems including recirculating and drain to waste systems.

Compatible with Bluelab Pro Controller and most Bluelab DoseTronic™ models¹.

¹ Bluelab PeriPod is compatible with Bluelab DoseTronic's manufactured after 2010. Contact Bluelab Customer Support for more information.

1.2 What's in the box?

Please check and verify the box contents match the below list:

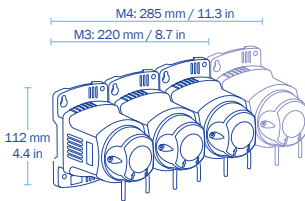

Pump 1 is set as pH by default. All pumps can be set as pH or nutrient in Bluelab Connect.

Bluelab PeriPod M3

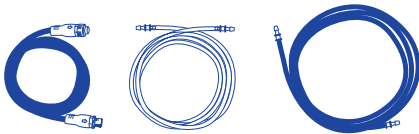

Dosing cable

4 metres / 13 feet pH Tubing

4 metres / 13 feet Nutrient Tubing per pump



24V DC 2Amp power supply



Mounting Screws

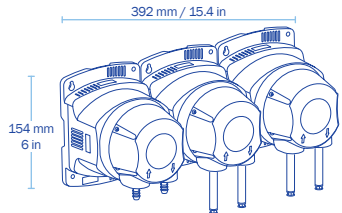

Pump 1 is set as pH by default. All pumps can be set as pH or nutrient in Bluelab Connect.

Bluelab PeriPod L3



Dosing cable

4 metres / 13 feet pH Tubing

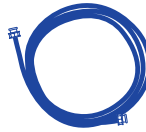

3x 4 metres / 13 feet Nutrient Tubing



Mounting Screws



24V DC 2Amp power supply (24V DC 5A on limited stock)

1.3 How the Bluelab PeriPod works & installation example

The Bluelab PeriPod is designed to be connected to a Bluelab Pro Controller with inlet tubes placed into pH adjuster and nutrient stock solutions, and the outlet tubes placed into the reservoir. The Bluelab PeriPod can be integrated into a variety of growing systems including but not limited to recirculating and drain to waste systems. Up to three M3 or M4 PeriPods can be connected together (max. 12 pumps) to dose multi-part nutrients. They are not designed for use as an inline doser.

PeriPod M3

(Default settings - Can be set as pH or nutrient pumps in Connect)

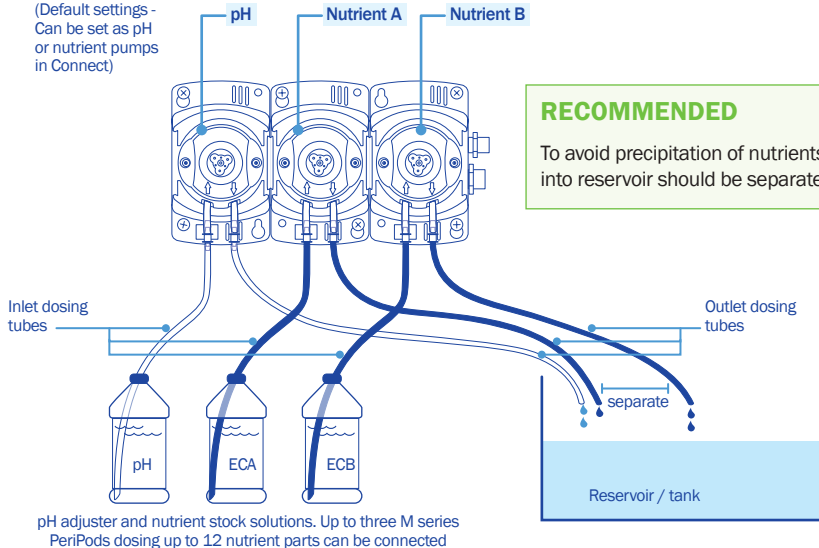

Dosing

The Bluelab PeriPod responds to electrical dosing 'triggers' received from the Bluelab Pro Controller, and pumps the pH adjuster and nutrient stock solutions into the reservoir as needed through peristaltic pumps.

Peristaltic pumps work by compressing a flexible tube between rollers and the inside wall of the pump housing. When these rollers are rotated, liquid is squeezed through the tube and pushed out of the pump outlet. At the same time, as the rollers move past a section of tube, the tube opens, creating a suction that pulls liquid into the pump inlet for the next roller to squeeze out of the outlet. Chemical resistant tube allows acids and alkalis to be pumped direct from their containers, through the pumps, and into the nutrient reservoir.

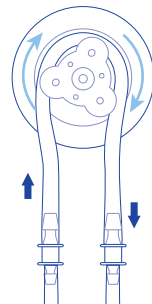

The amount of liquid that is pumped through a peristaltic pump can vary due to a number of factors including:

- Age and condition of peristaltic tubing.
- Pump mounting height and tube length.
- Viscosity and specific gravity of the liquid being pumped.
- Environmental temperature.

To counteract these variations each EC peristaltic pump can be individually calibrated to help ensure the desired amount of solution is dosed relative to that being dosed by the other EC pumps in the Bluelab PeriPod chain.

2.0 Safety Precautions

IMPORTANT

BEFORE installation and first use - read this section. To ensure safe setup and operation of the Bluelab PeriPod follow all precautions in this manual. All the safety instructions and/or warnings given throughout this manual relate to the specific features of the Bluelab PeriPod.

2.1 General safety precautions

Follow all generally accepted safety practices and procedures required when working with and around electricity, including the following:



WARNING

- This product is designed for pumping liquids only.
- Never use in or around flammable gases. Doing so creates risk of smoke, fire, or explosion.
- Never use a voltage that is different from that specified on the product.
- Do not touch the pump motor when removing it shortly after running. The motors get hot when operating and could cause serious burns.
- Never take the product apart or modify it except as described in this manual.
- Never leave any dangerous liquids inside the tubing when replacing or disconnecting tubing or pumps. Remaining dangerous liquids may cause serious injury. Always flush with water.
- Remove dangerous liquids from pumps and tubing when storing, or if product is not to be used for extended periods.
- Always flush tubing with water before changing from one dosing solution to another.



CAUTION

- Peristaltic tubing can degrade in certain conditions of use. Always check for signs of degradation and leaks, and replace tubing as required to ensure safe operation.

2.2 Chemical safety precautions

BlueLab recommend that you DO NOT handle concentrated acids or alkalis, however if you do, ensure that ALL generally accepted safety practices and procedures required when working with acidic and alkaline solutions are followed.



WARNING

- Follow all Manufacturer's storage, safety instructions and precautions when handling chemicals.
- ALWAYS neutralise acids and alkalis before cleaning up a spill or disposing of them.

3.0 Installing the BlueLab PeriPod

3.1 Mounting the BlueLab PeriPod

- 1 Select a suitable location that is:
 - Higher than both the reservoir and the pH and nutrient solutions. This will avoid siphoning from one to the other in the event of peristaltic tube failure.
 - NOT directly above the reservoir. This will avoid leaked solution entering the reservoir in the event of peristaltic tube failure.
 - Less than 1.5m from an electrical mains outlet.
 - Less than 400mm from the next PeriPod, if being used in a chain.
 - Less than 2m from the reservoir so that pump outlet tubing can reach easily.
 - Ideally less than 1.5m above pH adjuster and nutrient stock solutions. This will ensure pump suction is adequate to pump solutions. For heavy or viscous solutions a lower mounting height may be required.

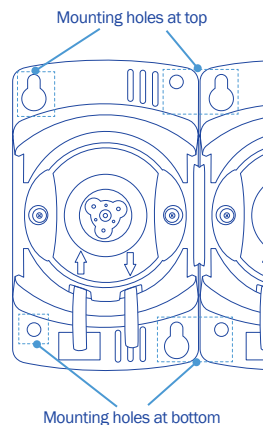

CAUTION

- Direct sunlight may result in increased damage to tubing and plastic components of the BlueLab PeriPod.

- 2 Attach to the wall by securing the screws through the mounting holes in the top and bottom of the case. It is recommended to place screws as indicated in the diagram.

Recommended mounting configuration:

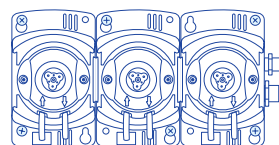

3.2 Setting up the inlet & outlet tubes

Straighten the dosing tubes before connecting. Bend tube in the opposite direction to its curve and straighten by running through closed fingers.

Each 4 metre / 13 foot length of tube requires cutting to be used as both inlet and outlet dosing tubes with connectors. Before cutting, ensure there is enough length for each. Cut the tubing on a 45° angle. This is important to avoid the tube becoming blocked due to suction at the bottom of the adjuster and nutrient solution bottles.

CAUTION

- Ensure you use the pH dosing tube with the pH adjuster solution. pH adjuster solution could damage nutrient tubing.

- 1 Set up the pH inlet dosing tube.

M Version: Insert the pH dosing tube connector into the LEFT pH pump tube.

L Version: Push one end of the pH dosing tube over the LEFT pH pump barb.

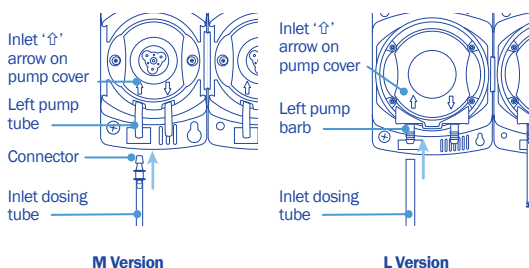

3.2 Setting up the inlet & outlet tubes continued

- Ensure the inlet dosing tube will reach the bottom of the pH adjuster container. Cut the inlet dosing tube to desired length.

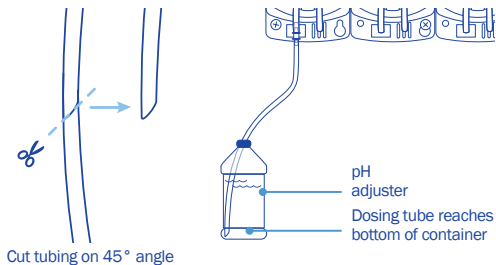

- Set up the pH outlet dosing tube.

M Version: use the remaining dosing tube with the connector, and insert the connector into the RIGHT pH pump tube.

L Version: Use the remaining dosing tube and push it onto the RIGHT pH pump barb.

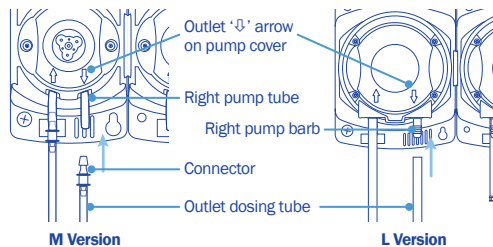

- Cut the outlet dosing tube so that the tube sits above the maximum solution level of the reservoir. The pH adjuster and nutrient solutions must drip into the nutrient reservoir.

Note: If the outlet dosing tubes are immersed in the reservoir it could create a siphon. This could possibly cause the solutions to flow into the reservoir or vice versa.

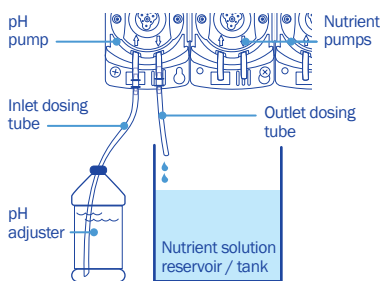

- To set up nutrient tubing and pumps, repeat steps 1-4 using the darker nutrient solution tubing. **For the L Version:** Insert and twist each connector of the nutrient dosing tube into each nutrient pump tube connector.

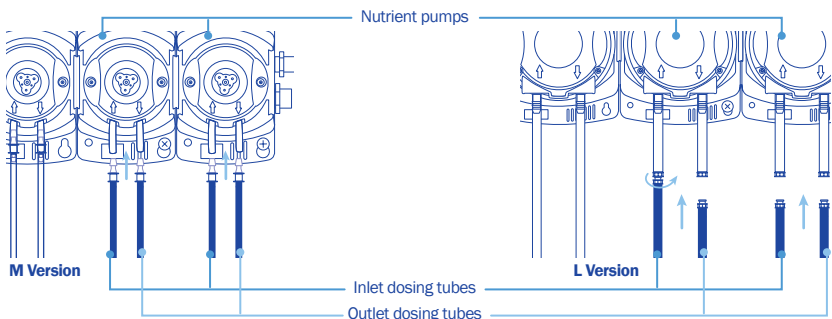

Note: If pH adjuster or nutrient stock solution being used has solid particles suspended in it, then a sieve filter should be placed on the end of the tube to prevent tube blockages and potential damage to the peristaltic pumps.

A suitable sieve filter should suit tubing with 3mm or 1/8in ID for the M version, 8mm or 1/3in ID for the L version. The filter should be made from a material that is compatible with the pH adjuster or nutrient stock solution being used.

3.3 Bluelab PeriPod connection panel

The interface panel is located on the right hand side of the Bluelab PeriPod and provides the user interface to access its features.

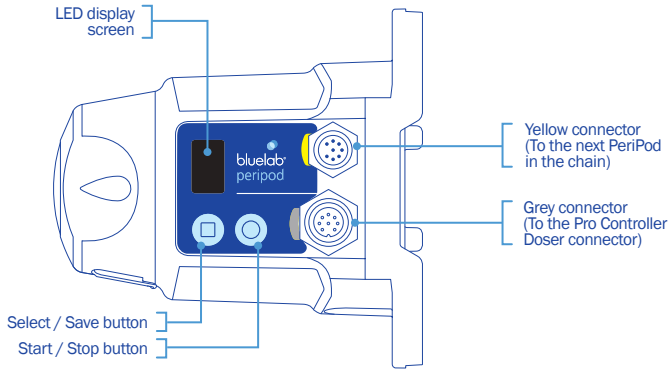

3.4 Connecting to a Bluelab Pro Controller

For ease of use Bluelab dosing cables are colour coded. Each end matches up with colours on the connector panel of the Bluelab PeriPod.

- 1 To connect the Bluelab PeriPod to the Bluelab Pro Controller, align pins and push the connector onto the GREY connector. Once pushed in turn the threaded collar of the connector clockwise to secure the connector in place.

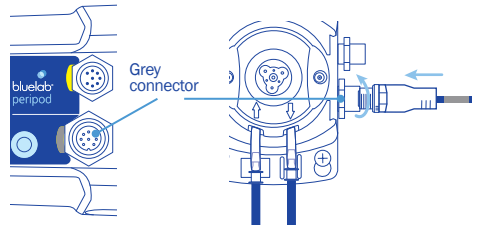

- 2 Then connect the other end (YELLOW end) to the doser connector of the Bluelab Pro Controller.
- 3 Connect the next PeriPod in the chain (if used) to the upper YELLOW connector of the previous PeriPod.

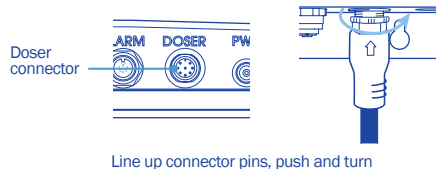

3.5 Connect power adaptor

- 1 Connect the power adaptor into the power receptacle in the base of the Bluelab PeriPod.
- 2 Plug the adaptor into the mains power supply. Switch on the power adaptor at the mains. The Bluelab PeriPod will complete a display test sequence. A GREEN dot in the lower right hand corner of the display indicates that the Bluelab PeriPod is powered ON, in stand-by mode and ready to dose.

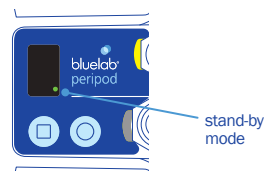
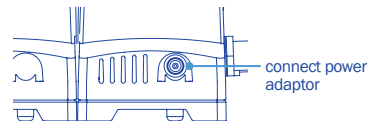

4.0 Set up and operation

4.1 Manual pump priming

It is recommended that after setup and before automatic dosing begins all pumps are manually primed with the solutions that they will dose during normal operation. This is done for each pump individually by following the process below.

- 1 Ensure that all dosing tubes are correctly installed, see Section 3.2, and the BlueLab Pro Controller (if connected) is in monitor mode.

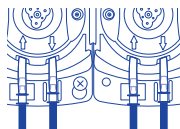

M Version

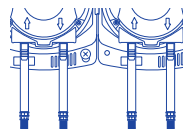

L Version

- 2 Short press the Select / Save button '□' to enter pump priming mode.

The LED display will show the letter P to indicate that priming mode has been entered then either a 1, 2 or a 3 will be displayed to indicate which pump is selected.

Press Select / Save button '□'

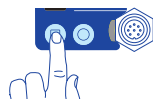

- 3 Change the selected pump by short pressing the Select / Save button '□'. This will change the displayed number between 1, 2 and 3.



M Version pump selection



Priming mode

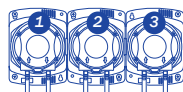

L Version pump selection



Pump to be primed

- 4 To begin priming the selected pump short press the Start / Stop button 'O'. The pump will begin running and the LED display will show a DOT in the bottom right corner (along with the pump number) to indicate that the pump is being primed.

Note: As a safety precaution the pump will stop after around two minutes, and return to standby mode. If further priming is required, simply re-enter priming mode, select the pump again, and start priming as before.

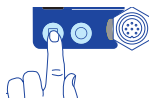

Press Select / Save button '□'

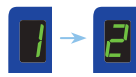

Change pump

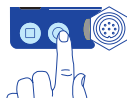

Press Start / Stop button 'O'

- 5 Once the pump is primed short press the Select / Save button '□' to return to standby mode.



Pump being primed

- 6 To prime another pump repeat steps 1 to 5 above.

Note: The pump can be paused and restarted at any time during priming by short pressing the Start/Stop button 'O'.

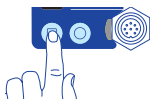

Press 'O' selection button once pump is primed

4.2 Calibrating nutrient pumps

Bluelab recommends that pumps are calibrated on initial set up, whenever it is observed that different quantities of solution are being dosed, when changing nutrient type, and every 30 days. A pump set as a pH pump cannot be calibrated.

Dose rates of peristaltic pumps can vary for many reasons, including:

- Temperature of solution.
- Temperature of operating environment.
- Vertical mounting distance (height) from stock solutions.
- Age and condition of peristaltic tubes.
- Age and condition of pumps.
- Specific gravity and viscosity of stock solutions.

For these reasons the Bluelab PeriPod has a pump calibration feature that is designed to reduce these effects by providing a user calibration for each pump. Pump calibration is not required, however it does improve the dosing accuracy of each pump relative to the others, which is important when accurate dosing of several nutrient stock solutions into the reservoir is required.

The pump calibration is a simple process where equal volumes of solution are pumped through each nutrient pump. The time taken to deliver this volume of solution is measured by the Bluelab PeriPod which will then adjust each pump's running time during dosing in order to deliver the same quantity of solution from each pump.

To complete calibration you will need; an empty transparent container that is able to hold approximately 300ml / 10oz for M versions, or 3000ml / 100oz for L versions, a marker pen, and a stop watch or similar.

⚠ CAUTION

- If calibrating pumps, ensure ALL pumps in the PeriPod chain are calibrated.
- To ensure calibration accuracy, the solution used during the calibration of each pump MUST be the same solution that will be dosed by that specific pump during normal operation.
- Pump calibration should be done with the Bluelab PeriPod and inlet tubing fully installed and primed as it would be during normal operation.
- The maximum running time for a pump during calibration is 3 minutes. If this time is exceeded the calibration will fail (the PeriPod will display "F" then "A", "I", "L", leave calibration mode and return to standby). It will not save calibration for that pump. If a pump takes longer than three minutes to deliver the required amount of solution it is likely there is a problem with the pump. See Section 5.3 Troubleshooting.

With the Bluelab PeriPod and dose tubing fully installed and primed, and the Bluelab Pro Controller in monitor mode (if connected):

- 1 Select the first nutrient pump to be calibrated, remove the outlet dosing tube from the pump outlet and place your empty transparent container underneath the pump outlet tube so that nutrient pumped through the pump will flow into the empty transparent container and NOT into the reservoir.

Note: Carefully remove the outlet dosing tube from the connector to remove for M3 version.

- 2 Power up the Bluelab PeriPod. The LED Display should show a dot in the lower left hand corner of the display indicating it is in standby mode.

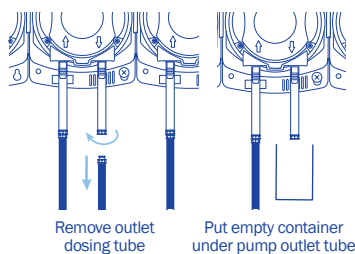

Power up in standby mode



4.2 Calibrating nutrient pumps continued

- 9 Enter pump calibration mode again with a long press of the Select / Save button '□' (long press = ~2 seconds).
The LED display will show the letter P, then C, A, L, once pump calibration mode has been entered. A 2 or 3 will be displayed to indicate which pump will be calibrated.

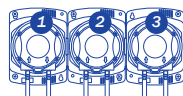

- 10 If required, press the Select / Save button '□' to switch to the next pump to be calibrated. Repeated presses will cycle through all of the nutrient pumps in that PeriPod.



Pump to be calibrated



- 11 To begin calibrating the pump short press the Start / Stop button 'O'.

The pump will begin running and the LED display will show a rotating bar to indicate that the pump is running.

This time stop the pump with a short press of the Start / Stop button 'O' once the solution level has reached the mark made on the container in STEP 6 above. The LED display will show a dash.



Let pump run until solution reaches the marker line

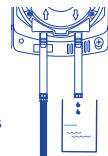

Note: The pump can be paused at any time during calibration by short pressing the Start / Stop button. Push it again to restart the pump and continue calibration.



Press '□' selection button to save calibration

- 12 Press the Select / Save button '□' to save the calibration for this pump. The LED display will show S A V E to confirm that the calibration has been saved.

- 13 When all of the nutrient pumps in the PeriPod chain have been calibrated, calibration is complete. Re-attach the nutrient dosing tubes to the peristaltic pump tubes.

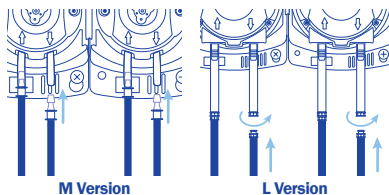

Note:

Pump calibration can be repeated at any time, however it is recommended that calibration is done at least every 30 days.

Once the first calibration has been carried out, calibration of any pump can be carried out at any time using the marked solution container without the necessity of timing the first pump, however it is recommended that all all pumps in the PeriPod chain are calibrated whenever calibration is carried out.

Once calibrated, the pumps will be turned on and off at intervals by the BlueLab PeriPod while dosing in order to dose the correct amount, rather than both pumps continuously dosing. This is normal operation.

Calibration times of greater than three minutes are not allowed, and will result in a failed calibration. Resetting the BlueLab PeriPod to an un-calibrated state can be carried out by pressing and holding both Select / Save '□' and Start / Stop 'O' buttons while powering up. If any PeriPods in the pod chain are reset, it is recommended to recalibrate them all.

5.0 Multi-part Nutrient Dosing with BlueLab PeriPods

The BlueLab PeriPods can be used with the BlueLab Pro Controller and BlueLab Connect to dose multi-part nutrients in varying proportions, according to a feed chart or feed schedule.

Overview of Multi-part nutrient dosing

Multi-part nutrient dosing allows dosing of nutrients into a reservoir according to a feed chart or feed schedule. These are often provided by the nutrient manufacturer.

FRODO'S FEED CHART			NUTRIENTS						*all measures in ml/US gal and ppm 500 scale
Week	Required pH	Required PPM	Macro A	Macro B	Mini Macros	Mega Micro 1	Mega Micro 2	Special Sauce	
1	5.8	450	8 ml	8 ml	2 ml	1 ml			
2	5.8	650	10 ml	10 ml	4 ml	2 ml			
3	5.8	650	12 ml	12 ml	5 ml	2 ml		1 ml	
4	5.8	1400	14 ml	14 ml	5 ml	5 ml		3 ml	
5	5.8	1100	14 ml	14 ml	5 ml	5 ml		3 ml	
6	5.8	1100	14 ml	14 ml	5 ml		5 ml	3 ml	
7	5.8	800	12 ml	12 ml	5 ml		5 ml	3 ml	
8	5.8	450	10 ml	10 ml	5 ml		5 ml		

Multi-part nutrient dosing can be selected in **Connect** when a suitable Pro Controller/PeriPod combination is detected. It is enabled in the Pro Controller **Nutrient Dosing** screen.

Each pump in the PeriPod or the PeriPod chain of up to three PeriPods can be set as a pH pump, an EC (nutrient) pump, or it can be turned off if not currently needed.

The nutrient proportions are calculated automatically from the feed chart quantities directly entered into Connect by the user.

When the Pro Controller initiates dosing, the PeriPods use the calculated proportions to switch individual pumps on and off on during dosing, so that they dose the nutrients in the correct proportions. For example, if one pump is set to 10 ml/gal and another set to 5 ml/gal the first pump will dose for twice as long as the second pump.

When the nutrient proportions change (a new line or week in the feed schedule), the reservoir should ideally be emptied, filled, and dosed up using the new ratio. This avoids unwanted nutrients remaining in the reservoir, and smaller components taking too long to come to the correct concentrations.

When the nutrient proportions change (a new line or week in the feed schedule), **the reservoir should ideally be emptied**, filled, and dosed up using the new ratio. This avoids unwanted nutrients remaining in the reservoir, and smaller components taking too long to come to the correct concentrations.

5.1 Reservoir size

Because 100 seconds total dosing time is required in order for the PeriPod to accurately dose, it's clear that there is a minimum reservoir size required. If the reservoir doses up to the required EC before the 100 seconds dosing is up, the nutrients may not be properly balanced.

If the reservoir that will be used is less than about 25 gallons (100 litres)(for an M series PeriPod chain), we suggest diluting **all of the nutrient components** by adding **an equal volume of water**. This will double the dosing time, ensuring that 100 seconds dosing time is achieved. **Remember to label the containers to indicate that they are diluted.**



5.2 Starting with multi-part nutrient dosing

Setting up the PeriPods and Connect

5.2.1 Setting up the PeriPods

IMPORTANT

The PeriPod doses small volumes of nutrient into the reservoir so results in less precipitating nutrients, but to further ensure this is minimised:

- Separate all nutrient tubes where they enter into the reservoir
- Always have sufficient and continuous mixing in the reservoirs (more is better)
- Some nutrient components or additives (e.g. silicon) are extremely prone to precipitation. Dilute precipitation prone nutrients or additives to very dilute levels before dosing. Multiply the dose value (ml/gal) by the dilution rate and enter into Connect™ to retain the same ratio. Continuous addition in dilute form results in some of the nutrient/additive always being available, even if precipitation over time is expected.

- 1 Mount the PeriPods as described in the PeriPod Manual.
- 2 Ensure each pump is drawing from the correct nutrient part. Labelling the pumps with the nutrient types in the feed chart is a good idea.
- 3 Connect the PeriPods in a daisy chain with the dosing cables. The dosing cable and the PeriPod connectors are colour coded to make this easier.

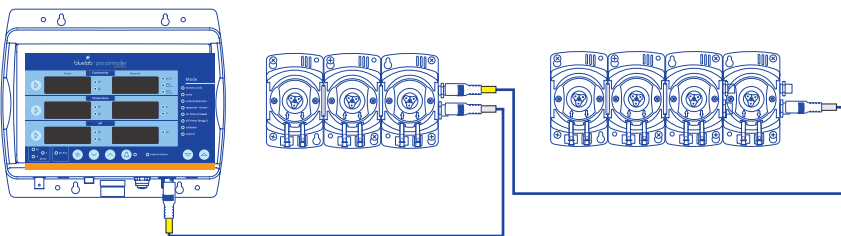

- 4 Ensure the Pro Controller and all of the PeriPods are powered up. If it is the first time the PeriPods have been connected to the Pro Controller, a “Pod Change – Accept” message will be displayed on the Pro Controller. Check that all of the PeriPods are correctly set up, powered up and connected, with all required nutrient parts and pH adjusters in place, then press the Pro Controller brightness button to “accept” the pod chain. This prompts the Pro Controller to “remember” the details of all of the pods and pumps, so it can communicate with them correctly.

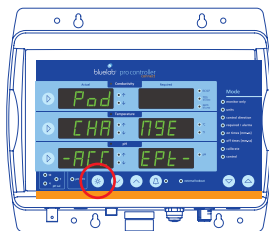

- 5 Prime and carry out a calibration of the PeriPod pumps if desired (see section 4.2 of this manual). Note: The “Pod Change” message does not need to be accepted during priming or calibration.

5.2.2 Setting up Connect

- 1 In the Connect global Settings screen, select the units of the quantities that will be entered in the multi-part nutrient dosing screen (ml, ml/gal, ml/l are available). This is likely to be the units used in the nutrient feed chart or schedule.



- 2 In the Connect Pro Controller Nutrient Dosing screen, enable Multi-part nutrient.



- 3 Click on the pump name of each nutrient pump and enter the name of the nutrient component it will be dosing (e.g., 5% Nitric, Grow A, Grow B etc.).



- 4 Select the pump function – pH, Nutrient (EC) or Off - by using the drop-down box for each pump. All pumps should be either set up or switched off.
- 5 Enter the nutrient quantities for each pump (probably taken from a nutrient feed schedule, or feed chart).

IMPORTANT

The Pro Controller will not use these numbers to dispense a particular quantity. Connect uses them to calculate nutrient proportions (these proportion are displayed as percentages, and can be seen changing as new quantities are entered). The Pro Controller/PeriPods will continue to dose in these proportions until the correct EC is reached.

- 6 Use the left and right arrows at the side of the screen to navigate between PeriPods in order to set up the pumps in each.
- 7 Save the setup to file, if it is likely to be used again. Click “Save to file...” and choose a location for saved files. A saved setup can be loaded and used by clicking “Load file...”
- 8 Click “Apply” to send the information to the Pro Controller/PeriPods.
- 9 Check all equipment is correctly installed and set up, and enter Control mode to start dosing. Nutrients will be dosed in the proportions entered from the feed chart line up to the required EC value.

IMPORTANT

Remember to set or check the EC and pH required values, on/off times and alarms, in Device Settings if loading a file, as these settings are not saved in the setup files. See the BlueLab Pro Controller manual for more information on setting dosing settings

5.2.3 Calculating the on time with multi-part nutrients

- 1 From the feed chart or schedule, find the **largest (by volume) nutrient component**.

Example: MaxiVeg requires 18 ml/gal – all the others take less.

FRODO'S FEED CHART

Week	Required pH	Required EC	Macro A	Macro B	MaxiVeg	Mega Micro 1	Mega Micro 2	Special Sauce
1	5.8	0.8	8	8		1 ml		
2	5.8	0.8	10	8	8	2 ml		
3	5.8	1.0	12	8	14	2 ml		1 ml
4	5.8	1.0	12	8	18	5 ml		3 ml
5	5.8	1.2	12	8	18	5 ml		3 ml
6	5.8	1.2	12	12			5 ml	3 ml
7	5.8	1.0	12	12			5 ml	3 ml
8	5.8	0.5	10	10			5 ml	

*all measures in ml/US gal and ppm 500 scale

- 2 Then, work out **how many doses are required** to take a reservoir from newly filled to dosed up. This is simply based on the required EC.
Example: 1.2 EC required = 12 (minimum) doses (We can only shift it 0.1EC with each dose – otherwise, we'll overshoot).
- 3 Work out **how much of the nutrient component is used** when fully dosing up the reservoir.
Example: Nutrient part A is added at the rate of 18 ml per gallon (from the schedule, above). My reservoir is 100 gallons so I need: 1800mls (1.8 litres) total.
- 4 Now we can work out **how big the maximum dose** should be,
Example: 1800ml total divided by 12 doses (found earlier) equals 150ml per dose.
 $1800/12 = 150\text{ml}$
- 5 Which gives us **the on-time** we need.
Example: My M3 pumps dose 120ml per minute, which is 2 ml per second, so
 $150/2 = 75\text{ seconds}$.

Remember, this is the **biggest we can have it**, so we can reduce it a bit, to stop overshooting. So, **60 seconds** would be a good starting point. It can be tweaked later, if needed.

Ensure that the nutrient / pH output tubes from the PeriPods are separated where they enter the reservoir to avoid precipitation problems.

6.1 Maintenance

- Peristaltic pump tubing has a finite life and should be replaced periodically to maintain stable performance. Refer to the Bluelab website or the back of this manual for information on spare parts.
- Flush pumps and tubing with water when product is going to be unused for more than one month.
- If re-installing after long periods of storage, initial setup procedures should be carried out.
- If you notice sudden or significant changes in flow rate see the troubleshooting guide in section 5.3 and check for signs of damage or wear.



WARNING

Always flush tubing and pumps with clean water BEFORE performing any maintenance on pumps or tubing. This ensures that all dangerous chemicals are flushed out of the tubing and pump, reducing accidental harm or injury.

6.2 Firmware upgrading

- 1 When prompted by the Bluelab Connect™ software that new firmware for the Bluelab PeriPod is available, upgrade it to ensure optimum functionality and reliability. The computer running Bluelab Connect software must be connected to the internet to receive firmware update information.

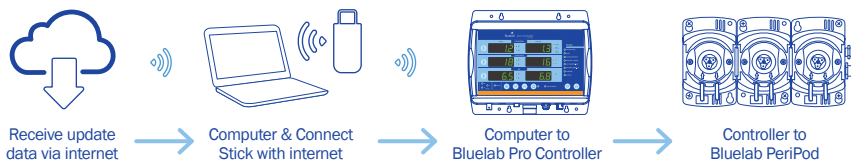

6.3 Troubleshooting guide

PROBLEM	PROBABLE CAUSE	CORRECTION
Pumps not turning.	Pro Controller currently in an off time	Wait until next on time starts.
	Required EC/pH level met.	No action required.
	Bluelab Pro Controller is in alarm - dosing is locked out.	Check Pro Controller display or Connect to identify alarm cause, and correct it.
	Bluelab Pro Controller not set to control.	Ensure Bluelab Pro Controller is in control mode (refer to Bluelab Pro Controller Manual).
	Required dosing levels not correctly set.	Ensure Bluelab Pro Controller is set up with correct required levels for EC/pH (refer to Pro Controller Manual).
	Power not connected.	Check power supply is plugged in. If there is a green dot in the bottom right corner of the display the Bluelab PeriPod is correctly powered.
	Bluelab PeriPod not connected properly.	Check the connections between the Bluelab PeriPod and the Bluelab Pro Controller.
	Cassette is damaged.	If you can hear the motor running, but the cassette isn't spinning, check cassette and motor spindle. Replace if damaged.
	Motor damaged.	Replace motor.

6.3 Troubleshooting guide continued

PROBLEM	PROBABLE CAUSE	CORRECTION
Pump(s) not pumping but are turning.	Nutrient stock/pH adjuster tank is empty.	Replenish nutrient.
	Tube is blocked.	Remove and unblock tube, rinse with water and reattach.
	Tube is twisted.	Go through all the tubing (including that going into the cassette) and straighten out any kinks.
	Tube is cut flat and touching the bottom of the nutrient tank.	Cut the bottom of the tube at a 45° angle.
	Split or hole in tubing.	Replace tubing.
	Damaged cassette/worn peristaltic tube.	Replace cassette.
Pumps are not pumping the expected quantities / Pump(s) flow rate decreased / Pump(s) failing calibration	Calibration is out of date.	Re-calibrate pumps.
	Nutrient has changed.	Re-calibrate pumps.
	Tube is blocked.	Remove and unblock tube, rinse through with water and reattach.
	Nutrient levels very low.	Ensure tube is always in the nutrient even when levels are low.
	Tube is twisted.	Go through all the tubing (including that going into the cassette) and straighten out any kinks.
	Tube is cut flat and touching the bottom of the nutrient tank.	Cut the bottom of the tube at a 45° angle.
	Split or hole in tubing.	Replace tubing.
	Damaged cassette/worn peristaltic tube.	Check pump output (approx. 120ml/min, M series; 1,200ml/min L series). If low, replace cassette. If cassette is damaged, replace cassette.
EC/pH not changing.	Damaged pump.	Replace pump.
	Inlet dosing tube not in nutrient stock solution/pH adjuster.	Put dosing tube back in nutrient stock solution/pH adjuster, and re-prime pump.
	Outlet dosing tube not in reservoir.	Put dosing tube back in reservoir.
	Run out of nutrient/pH adjuster.	Replace nutrient/pH adjuster, and re-prime pump.
	Tube is twisted.	Go through all the tubing (including that going into the cassette) and straighten out any kinks.
	Tube is cut flat and touching the bottom of the nutrient tank.	Cut the bottom of the tube at a 45° angle.
	Split or hole in tubing.	Replace tubing.
	Damaged cassette/worn peristaltic tube.	Check pump output (approx. 120ml/min, M series; 1,200ml/min L series). If low, replace cassette. If cassette damaged, replace cassette.
Damaged pump.	Replace pump.	
Overshooting required values	Poor mixing in reservoir.	Add mixer to reservoir.
	Off time too short.	Increase off time (refer to Bluelab Pro Controller Manual).
Too many doses needed to change measured value.	On time too short.	Increase on time (refer to Bluelab Pro Controller Manual).
Never reaching desired EC/pH.	On time too short/off time too long	Set on/off times correctly (refer to Bluelab Pro Controller Manual).
	Pumps too small for reservoir.	Move to the L3 version of the Bluelab PeriPod if possible or add more Bluelab PeriPod (in a daisy chain) for larger reservoirs. Contact customer support for advice.
EC/pH is never dosing.	Bluelab Pro Controller control direction is set incorrectly	Change Bluelab Pro Controller control direction setting to the correct direction, and ensure the correct solution/adjuster is being used.



6.4 Technical specifications

	M3 / M4	L3
Default Function (Can be changed in BlueLab Connect)	Pump 1: pH, Pump 2: EC A, Pump 3: EC B, Pump 4 (M4): EC C.	Pump 1: pH, Pump 2: EC A, Pump 3: EC B
Pump flow rate	120 ml/min ¹	1200 ml/min ¹
PeriPod size selection	Refer to bluelab.com for discussion on pump sizing	
Peristaltic tube lifetime	>750hrs pump running time	
Peristaltic pump motor lifetime	>1500hrs pump running time	
Solution Temperature	5 - 50 °C / 41 - 122 °F	
Environment Temperature	5 - 40 °C / 41 - 104 °F	
Flow rate accuracy at 20 °C / 68 °F	±10% ^{1,2}	
Pump Calibration	Yes	
Firmware upgradable	Yes	
Power Source	Input: 100-240 Vac, 50-60 Hz, 5 VA Output: 24Vdc 2 Amp, 24Vdc 5 Amp (on limited L3 stock)	
Certifications	CE, FCC, IC.	

¹ Pump flow rate and dosing accuracy is dependent on, among other things; temperature, liquid being pumped, age and condition of tubing. Therefore the actual flow rate achieved will vary between each setup and with time.

² With no valid pump calibration.

6.5 Material specification for tubing

	Peristaltic tubing	pH tubing	Nutrient tubing
Food Grade	YES	YES	NO
Standards Met	USP Class VI, ISO 10993, FDA CFR 21, FDA 3-A, NSF 51, REACH, RoHS	USP Class VI, FDA CFR 21	RoHS

6.6 pH adjuster compatibility for tubing³

	Peristaltic tubing (PharMed BPT)	pH Tubing (PTFE)	Nutrient tubing (LDPE)
Nitric Acid	<35%	Concentrated	<10%
Phosphoric Acid	<85%	Concentrated	<40%
Sulfuric Acid	<30%	Concentrated	<50%
Citric Acid	<20%	Concentrated	<10%
Potassium Hydroxide	Concentrated	Concentrated	Concentrated
Potassium Carbonate	Concentrated	Concentrated	Concentrated
Potassium Silicate	Unknown	Concentrated	Concentrated

³ The chemical concentrations stated in the above table are just a guide. Variations in temperature, pressure, or UV exposure may cause tubing failure which could lead to serious injury if proper safety precautions are not followed. For this reason it is recommended that the tubing be tested by the user with the desired chemical in the specific application to determine ultimate suitability before using them. No warranty (neither express or implied) is given that the information in these tables is accurate or complete or that any material is suitable for any purpose.



Bluelab pH Up and pH Down Solutions

Optimum growth needs optimum pH. And we make optimum simple.

If your pH isn't in the right range – and that's 5.5-6.5 for most plant varieties – your nutrients are likely wasted.

We say that's a problem you don't need. At Bluelab, we want our customers to have optimum growth and the best plants possible. So we've made it easy to raise or lower pH levels, whenever you need, and keep them just where they should be.

Bluelab's pH Up and pH Down are formulated to the highest standards. Just add what's required to lift or reduce growing solution acidity. Your plants will thank you for it. The main thing is, you'll see the difference in your harvest. Optimum inputs. Optimum results. Simple.



Available in:



› Bluelab pH Up 500ml

› Bluelab pH Down 500ml

› Bluelab pH Up 1 Liter

› Bluelab pH Down 1 Liter

› Bluelab pH Up 1 Gallon

› Bluelab pH Down 1 Gallon

Bluelab Peristaltic Pumps

Replacement pump motor and cassette for Bluelab PeriPod.

Quick and simple to replace when required.

All you have to do is order a replacement from your supplier!

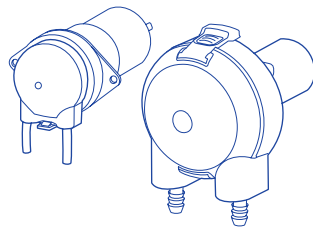

Bluelab Cassette

Replacement cassette for Bluelab Peristaltic Pumps.

Quick and simple to replace when required.

All you have to do is order a replacement from your supplier!

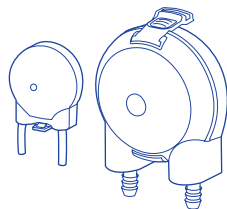

Bluelab Dosing Tubing

Replacement pH and nutrient tubing, 4 meters / 13 feet in length.

For use with Bluelab PeriPod and pH adjuster or nutrient solution.

Dosing tube is specific to version of Bluelab PeriPod, so replacement is easy. Simply order pH or nutrient tubing to suit M or L type. Bluelab pH Dosing Tube can be used with undiluted Bluelab pH Up or Bluelab pH Down.

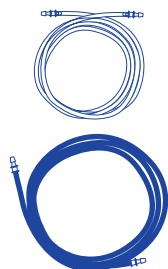

Replacement Tubing for Bluelab PeriPod M



limited written warranty.

The Bluelab PeriPod comes with a 2 year limited written warranty, 6 months for pumps and tubes. Proof of purchase required. For full terms and conditions visit bluelab.com/product-warranty.



connect.

If you need assistance or technical advice - we're here to help you.

North America: +1-855-525-8352 **Europe:** +31 (0) 85 05 16 848

Rest of the World: +64 7 578 0849 **Email:** support@bluelab.com



get online.

-  facebook.com/bluelabofficial
-  blog.bluelab.com
-  youtube.com/bluelabcorporationlocation



Bluelab Corporation Limited

8 Whiore Avenue, Tauriko, Tauranga 3110,
New Zealand



Instruction Manual English PERIPOD_V4.2_200122
© Copyright 2018, all rights reserved, Bluelab Corporation Limited